

PRODUCT DATASHEET

FL FLEX P 130W ML 830 R60 WAL

FLOODLIGHT FLEX RADIAL SYMMETRIC 60 | Floodlight with radial symmetric light distribution for medium to high mast area lighting



Areas of application

- Coastal areas, like ports
- General outdoor area lighting
- Parking
- Suitable for indoor and outdoor sports facilities
- Architectural lighting
- Industry
- Direct replacement for luminaires using HID lamps

Product benefits

- Corrosion resistance C5: tested in environments with high salinity
- Serviceable luminaire: LED driver can be replaced
- Flexible application due to a range of different lumen packages and beam angles
- 3 cable entries for flexible use and easy connection between luminaires
- Integrated breather for preventing condensation inside the luminaire
- Energy savings of up to 91 % compared to halogen lamp floodlights
- Energy savings of up to 51 % compared to luminaires that use conventional discharge lamps
- No upper light output ratio (ULOR 0%) when mounted at 0° tilt
- Intelligent design of the water drain to prevent standing water
- Simple angle adjustment by locking every 2.5°
- Clear angular degree indication
- Key hole to ensure ease of installation

Product features



- Corrosion resistance C5 based on 1,500 hours salt mist spray test
- High luminous efficacy: up to 166 lm/W
- Multi Lumen function: 4 power steps selectable
- Daisy chaining possible
- High surge protection: up to 10 kV (L/N-PE), 6 kV (L-N)
- High lifetime (L70/B50): up to 120,000 h (at 25 °C)
- Lumen packages up to 70000 lm

TECHNICAL DATA

Electrical data

Nominal wattage	130 W / 110.5 W / 91.0 W / 71.5 W
Nominal voltage	220...240 V
Mains frequency	50...60 Hz
Nominal current	574.000 mA
Inrush current	65.6 A
Inrush current time T_{h50}	190 μ s
Max. number of luminaires per miniature circuit breaker B16	10
Max. number of luminaires per miniature circuit breaker C10	10
Max. number of luminaires per miniature circuit breaker C16	17
Power factor λ	> 0.90
Total harmonic distortion	< 20 %
Protection class	I
Surge capability (L-N)	6 kV
Surge capability (L/N-Ground)	10 kV
Operating mode	Integrated LED driver

Photometrical data

Luminous flux	19900 lm / 16900 lm / 14100 lm / 11300 lm
Luminous efficacy	153 lm/W / 155 lm/W / 158 lm/W
Color temperature	3000 K
Light color (designation)	Warm White
Color rendering index Ra	> 80
Standard deviation of color matching	5 sdc _m
Luminous intensity	20895 cd
Low flicker	Yes
Flickering metric (Pst LM)	<1
Stroboscope effect metric (SVM)	<0.4
Photobiological safety group acc. to EN62778	RG1
Beam angle	60 °

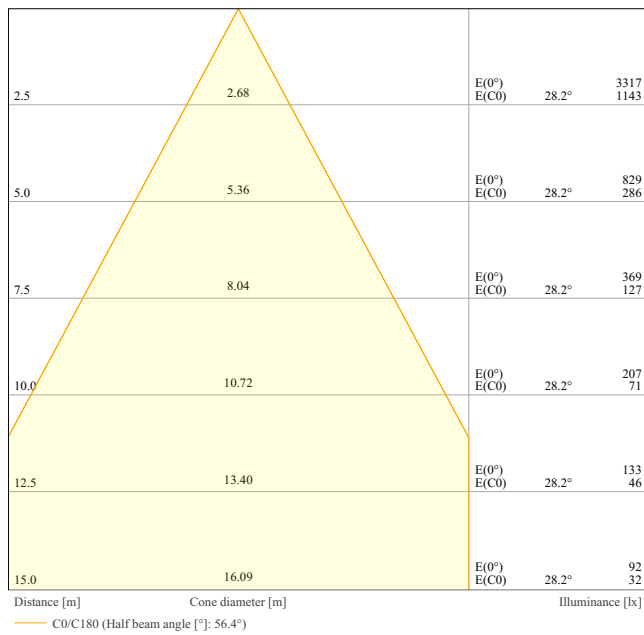

FL FLEX DA/P 130W 830 R60 WAL

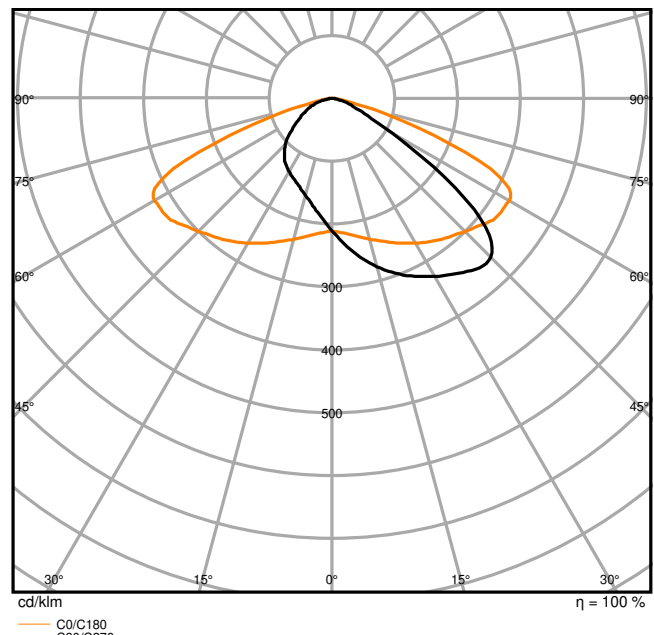

FL FLEX P 130W ML 830 R60 WAL LEDV

Dimensions & Weight

Length	492.00 mm
Width	361.00 mm
Height	68.00 mm
Product weight	5900.00 g

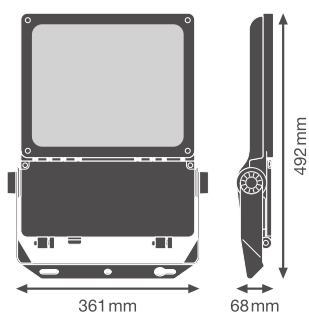

FL FLEX P WAL

Materials & Colors

Product color	White aluminum
Housing color	White aluminum
Body material	Aluminum
Cover material	Glass
Light emitting surface material	Glass
Glow Wire Test according to IEC 60695-2-12	850 °C
Mercury content	0.0 mg

Application & Mounting

Ambient temperature range	-30...+50 °C
Temperature range at storage	-30...+80 °C
Type of connection	Screwless terminal
Type of protection	IP66
Protection class IK (shock resistance)	IK08
Corrosion resistance class acc. to EN 12944	C5
Dimmable	No
Mounting type	Surface
Mounting location	Wall / Pole / Floor / Ceiling
Application environment	Outdoor
Adjustable	Yes
With light source	Yes

Lifespan

Lifespan L70/B50 at 25 °C	120000 h ¹⁾
Lifespan L80/B10 at 25 °C	100000 h ¹⁾
Lifespan L80/B50 at 25 °C	100000 h
Lifespan L90/B10 at 25 °C	50000 h
Number of switching cycles	100000

¹⁾ t[h]: L70 / B50 @ 25 °C (Ta), t[h]: L80 / B10 @ 25 °C (Ta), t[h]: L90 / B10 @ 25 °C (Ta)

Control gear

Output current	3750 mA
ECG - Output ripple current	< 10 %

Certificates & Standards

Standards	CE / CB / ENEC / UKCA
-----------	-----------------------

Luminaire with limited surface temperature, "D sign"	Yes
Replaceable light source (EPREL)	Not replaceable









Additional product data



Product remark	Available from December 2024
Added function	MULTI SELECT







EQUIPMENT / ACCESSORIES

- Delivery without cables
- Second cable gland included
- 2 rubber inserts for 6,5 - 7,5 mm cables included

DOWNLOAD DATA

Documents and certificates		Document name
	User instruction / safety instructions	FL FLEX P ON-OFF
	Legal information	Informationstext 18 Abs 4 ElektroG
	Legal information	Safety Insert G11205497
	Legal information	LSI FL FLEX
	Legal information	Legal insert G11231557
	Declarations of conformity	CE FL FLEX P
	Declarations of conformity UKCA	UKCA FL FLEX P
	Certificates	ENEC FL FLEX P

Photometric and lighting design files		Document name
	IES file (IES)	FL FLEX P 130W ML 830 R60 WAL LEDV
	LDT file (Eulumdat)	FL FLEX P 130W ML 830 R60 WAL LEDV

Photometric and lighting design files		Document name
	ULD file (DIALux)	FL FLEX P 130W ML 830 R60 WAL
	Light distribution curve type cone	FL FLEX DA/P 130W 830 R60 WAL
	Light distribution curve type polar	FL FLEX P 130W ML 830 R60 WAL LEDV
CAD/BIM files		Document name
	BIM Revit 3D	Floodlight Flex
	BIM Step 3D	FL FLEX 130W
Tender texts		Document name
	Tender documents	FLOODLIGHT FLEX RADIAL SYMMETRIC 60 130W ML 830 R60 WAL-en

LOGISTICAL DATA

Product code	Packaging unit (Pieces/Unit)	Dimensions (length x width x height)	Gross weight	Volume
4099854373350	Shipping box 1	572 mm x 402 mm x 119 mm	7203.00 g	27.36 dm ³

The mentioned product code describes the smallest quantity unit which can be ordered. One shipping unit can contain one or more single products. When placing an order, for the quantity please enter single or multiples of a shipping unit.

ADDITIONAL CATALOG INFORMATION

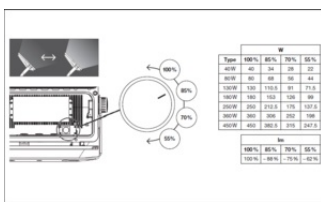

References / Links

– For Guarantee see www.ledvance.com/guarantee

DISCLAIMER

Subject to change without notice. Errors and omission excepted. Always make sure to use the most recent release.