

PRODUCT DATASHEET

DL COMFORT DN 205 20 W 3CCT IP54 WT

DOWNLIGHT COMFORT | Downlights with adjustable white light colors



Areas of application

- Direct replacement for luminaires with compact fluorescent lamps
- General illumination
- Bathrooms
- Kitchens
- Offices
- Corridors
- Foyers
- Shops
- Stairways

Product benefits

- Three light color in one luminaire: Warm White, Cool White, Daylight White
- Simple installation thanks to integrated driver
- Easy installation with fast connection
- 5 years guarantee

Product features

- Three light colors selectable via slide switch
- Type of protection: IP54
- Connector box with push wire terminal for tool-free connection
- Through wiring possible



TECHNICAL DATA

Electrical data

Nominal wattage	20.00 W
Nominal voltage	100...277 V
Mains frequency	50...60 Hz
Nominal current	230 mA
Inrush current	50 A
Inrush current time T_{h50}	100 μ s
Max. number of luminaires per miniature circuit breaker B16	13
Max. number of luminaires per miniature circuit breaker C10	10
Max. number of luminaires per miniature circuit breaker C16	17
Power factor λ	> 0.90
Total harmonic distortion	< 20 %
Protection class	I
Operating mode	Integrated LED driver

Photometrical data

Luminous flux	1720 lm / 1930 lm / 1810 lm ¹⁾
Luminous efficacy	90 lm/W ²⁾
Color temperature	3000 K / 4000 K / 5700 K
Light color (designation)	Warm White / Cool White / Cool Daylight
Color rendering index Ra	> 80
Standard deviation of color matching	< 5 sdc _m
Luminous intensity	-
Flickering metric (Pst LM)	-
Stroboscope effect metric (SVM)	-
Photobiological safety group acc. to EN62778	RG0
Photobiological safety group acc. to EN62471	RG0
Beam angle	60 °
UGR	< 22

1) Luminous flux dependent on selected color temperature: 1720 lm@3000 K/1930 lm@4000 K/1810 lm@5700 K

2) Value at 5700 K, different for other color temperatures

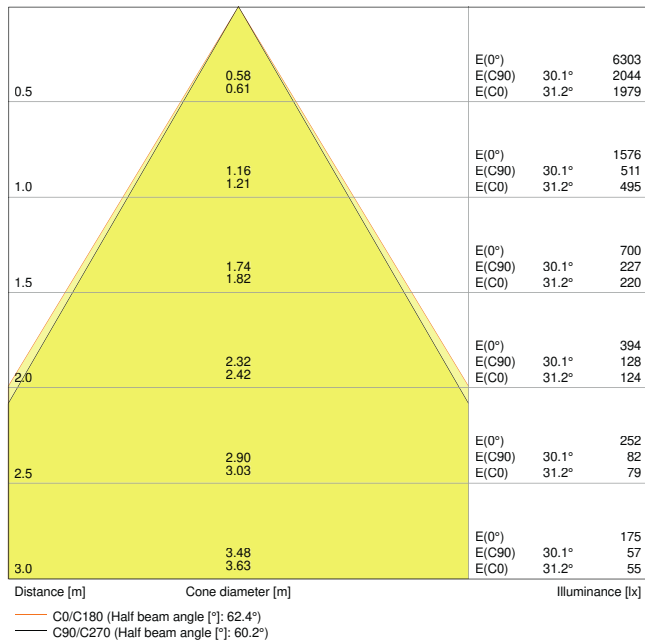

DL COMFORT DN205 20W3CCT 60DEG WT-3000K

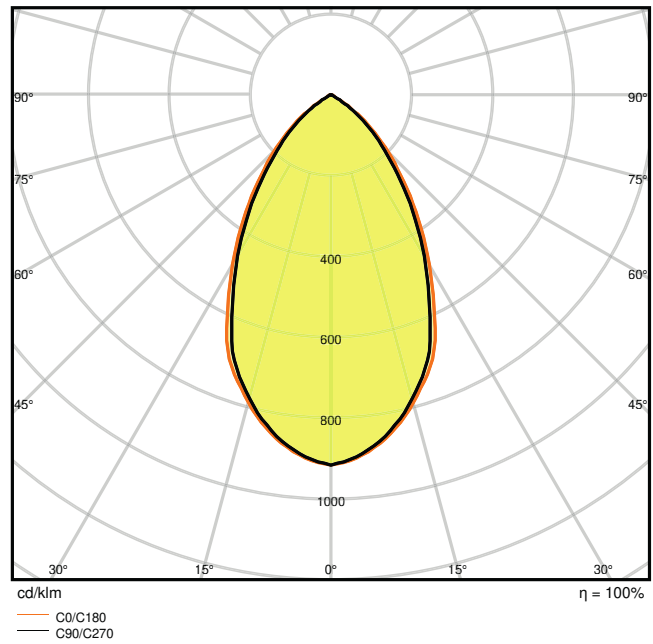

DL COMFORT DN205 20W3CCT 60DEG WT-3000K

Dimensions & Weight

Diameter	228.00 mm
Height	98.00 mm
Product weight	550.00 g

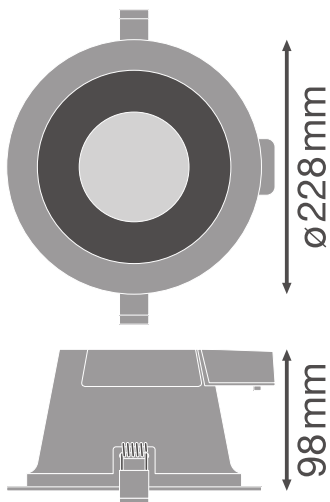

DL COMFORT DN205 25W

Materials & Colors

Product color	White
Housing color	White
Body material	Aluminum
Cover material	Polymethylmethacrylate (PMMA)
Glow Wire Test according to IEC 60695-2-12	650 °C
Mercury content	0.0 mg

Application & Mounting

Ambient temperature range	-20...+45 °C
Type of connection	Screwless terminal, 2-Pole
Type of protection	IP54/IP20
Protection class IK (shock resistance)	IK03
Dimmable	No
Mounting type	Recessed
Mounting location	Ceiling
Application environment	Indoor
Mounting diameter	205 mm
Mounting depth	125 mm
With light source	Yes

Lifespan

Lifespan L70/B50 at 25 °C	50000 h ¹⁾
Lifespan L80/B10 at 25 °C	43000 h ¹⁾
Lifespan L80/B50 at 25 °C	45000 h
Lifespan L90/B10 at 25 °C	30000 h
Number of switching cycles	50000

¹⁾ t[h]: L70 / B50 @ 25 °C (Ta), t[h]: L80 / B10 @ 25 °C (Ta), t[h]: L90 / B10 @ 25 °C (Ta)

Certificates & Standards

Standards	CE / CB / ENEC / TÜV SÜD
Luminaire with limited surface temperature, "D sign"	No
Ball shot safe	No
Replaceable light source (EPREL)	Not replaceable













Additional product data



Number of illuminants	Not relevant
Added function	MULTI SELECT



Safety advice

- All electrical connections must be made by a qualified person.
- Caution, risk of electric shock.
- The luminaires are not suitable for covering with thermally insulated material.
- Product in protection class I. All electrically conductive, metallic housing parts that can absorb voltage during operation or during maintenance in the event of a fault must be continuously connected to the protective earthing conductor.

DOWNLOAD DATA

Documents and certificates		Document name
	User instruction / safety instructions	DL COMFORT 3CCT
	Legal information	LI DL COMFORT
	Legal information	LSI_DL COMFORT 3 CCT
	Legal information	Informationstext 18 Abs 4 ElektroG
	Declarations of conformity	EU Declaration of Conformity DOWNLIGHT Comfort LEDV
	Declarations of conformity	Attestation-of-Conformity DOWNLIGHT Comfort TÜV
	Declarations of conformity UKCA	DOWNLIGHT COMFORT / DL UGR19
Photometric and lighting design files		Document name
	IES file (IES)	DL COMFORT DN205 20W3CCT 60DEG WT-3000K
	LDT file (Eulumdat)	DL COMFORT DN205 20W3CCT 60DEG WT-3000K
	ULD file (DIALux)	DL COMFORT DN205
	ROLF file (RELUX)	DL COMFORT DN205
	UGR file (UGR table)	DL COMFORT DN205 20W3CCT 60DEG WT-3000K

Photometric and lighting design files		Document name
	Light distribution curve type cone	DL COMFORT DN205 20W3CCT 60DEG WT-3000K
	Light distribution curve type polar	DL COMFORT DN205 20W3CCT 60DEG WT-3000K

CAD/BIM files		Document name
	BIM Revit 3D	Downlight-Comfort
	CAD STEP 3D	DL COMFORT DN205

Tender texts		Document name
	Tender documents	DOWNLIGHT COMFORT 205 20 W 3CCT IP54 WT-EN

LOGISTICAL DATA

Product code	Packaging unit (Pieces/Unit)	Dimensions (length x width x height)	Gross weight	Volume
4058075104105	Folding box 1	250 mm x 250 mm x 140 mm	667.00 g	8.75 dm ³
4058075104112	Shipping box 8	520 mm x 520 mm x 300 mm	7050.00 g	81.12 dm ³

The mentioned product code describes the smallest quantity unit which can be ordered. One shipping unit can contain one or more single products. When placing an order, for the quantity please enter single or multiples of a shipping unit.

ADDITIONAL CATALOG INFORMATION

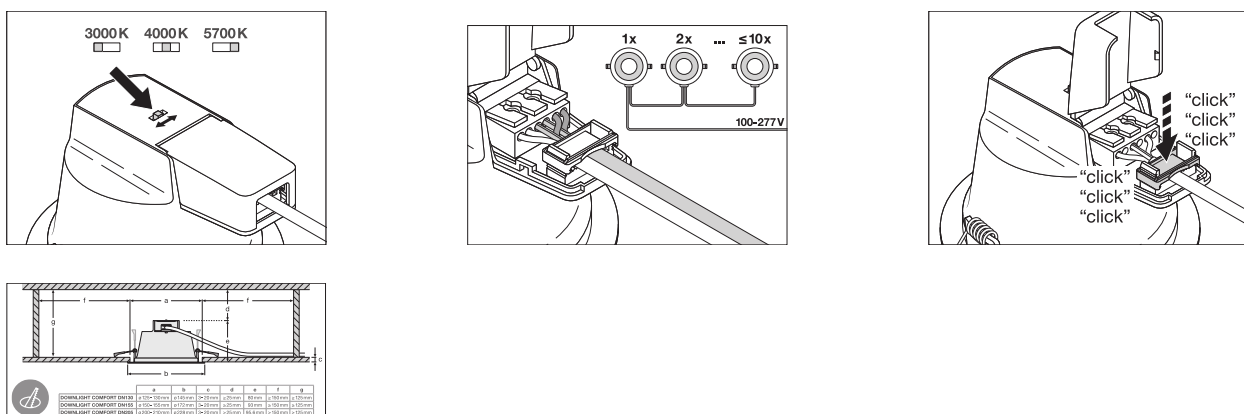

References / Links

– For Guarantee see www.ledvance.com/guarantee

DISCLAIMER

Subject to change without notice. Errors and omission excepted. Always make sure to use the most recent release.