

# PRODUCT DATASHEET

## DL SLIM SQ 155 12 W 4000 K WT

DOWNLIGHT SLIM SQUARE | Flat downlights with integrated driver, square shape



### Areas of application

- Direct replacement for luminaires with compact fluorescent lamps
- General illumination
- Public areas
- Stairways
- Corridors
- Foyers
- Shops

### Product benefits

- Very slim housing
- Low installation depth
- High luminous efficacy
- Energy savings up to 60 % (compared to luminaires that use CFL lamps)
- Very homogenous light
- Functional design
- Easy installation with fast connection
- Simple installation thanks to integrated driver

### Product features

- Small visible bezel
- Connector box with push wire terminal for tool-free connection



- Light guide made of non-yellowing PMMA for long lifetime

## TECHNICAL DATA

### Electrical data

Nominal wattage	12.00 W
Nominal voltage	220...240 V
Mains frequency	50...60 Hz
Nominal current	71.7 mA
Inrush current	15.6 A
Inrush current time $T_{h50}$	50 $\mu$ s
Max. number of luminaires per miniature circuit breaker B16	48
Max. number of luminaires per miniature circuit breaker C10	38
Max. number of luminaires per miniature circuit breaker C16	61
Power factor $\lambda$	0.50
Total harmonic distortion	< 20 %
Protection class	II
Operating mode	Integrated LED driver

### Photometrical data

Luminous flux	1020 lm
Luminous efficacy	85 lm/W
Color temperature	4000 K
Light color (designation)	Cool White
Color rendering index Ra	> 80
Standard deviation of color matching	< 6 sdc <sub>m</sub>
Luminous intensity	-
Flickering metric (Pst LM)	-
Stroboscope effect metric (SVM)	-
Photobiological safety group acc. to EN62778	RG0
Photobiological safety group acc. to EN62471	RG0
Beam angle	120 °

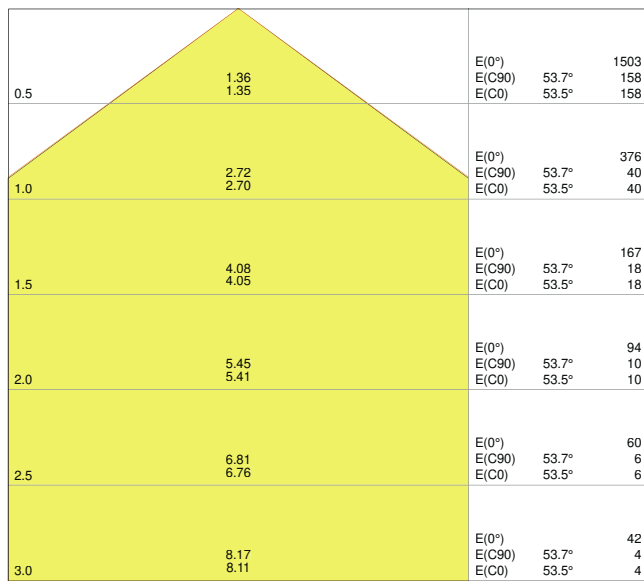

Distance [m]      Cone diameter [m]      Illuminance [lx]

— C0/C180 (Half beam angle [°]: 107.0°)  
— C90/C270 (Half beam angle [°]: 107.4°)

4058075052543 DL SLIM SQ155 12W 4000K WT IP20

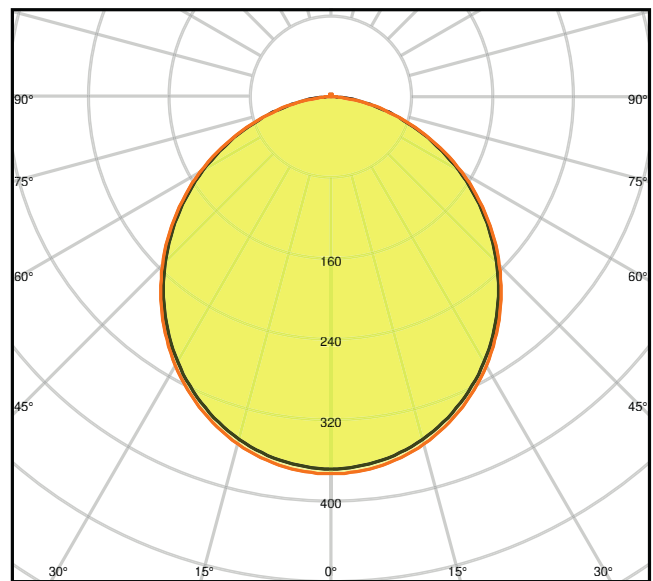

cd/klm      η = 100%

— C0/C180  
— C90/C270

4058075052543 DL SLIM SQ155 12W 4000K WT IP20

Dimensions & Weight

Length	169.00 mm
Width	169.00 mm
Height	30.00 mm
Product weight	308.00 g

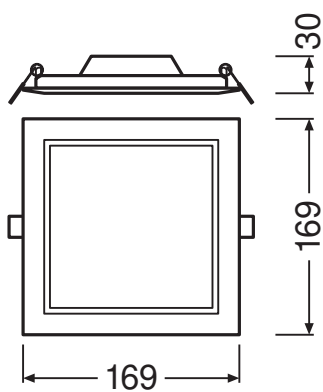

DL Slim SQ155 12W

## Materials & Colors

Product color	White
Housing color	White
Body material	Polycarbonate (PC)
Cover material	Polycarbonate (PC)
Light emitting surface material	Polycarbonate (PC)
Glow Wire Test according to IEC 60695-2-12	650 °C
Mercury content	0.0 mg

## Application & Mounting

Ambient temperature range	-20...+50 °C
Temperature range at storage	-30...+70 °C
Type of connection	Screwless terminal, 2-Pole
Type of protection	IP20
Protection class IK (shock resistance)	IK03
Dimmable	No
Mounting type	Recessed
Mounting location	Ceiling / Wall
Application environment	Indoor
Mounting length	155,0 mm
Mounting width	155,0 mm
Mounting depth	50,0 mm
LED module replaceable	Not replaceable
With light source	Yes

## Lifespan

Lifespan L70/B50 at 25 °C	30000 h <sup>1)</sup>
Lifespan L80/B10 at 25 °C	20000 h <sup>1)</sup>
Lifespan L90/B10 at 25 °C	12000 h
Number of switching cycles	50000

<sup>1)</sup> t[h]: L70 / B50 @ 25 °C (Ta), t[h]: L80 / B10 @ 25 °C (Ta), t[h]: L90 / B10 @ 25 °C (Ta)

## Control gear

Output current	180 mA
ECG - Output ripple current	< 6.5 %



## Certificates & Standards

Standards	CE / CB / EAC
Luminaire with limited surface temperature, "D sign"	No
Ball shot safe	No

Additional product data

Number of illuminants	Not relevant
-----------------------	--------------







Accessories Optional







Product image	Product name	EAN
	DL SLIM FRAME SQ 155 WT	4058075052666
	DL SLIM FRAME SQ 155 WT	4058075079410



EQUIPMENT / ACCESSORIES

– Surface mounting frames available as accessories

DOWNLOAD DATA

Documents and certificates	Document name
 Extended installation guide	User Instruction Downlight LED Slim
 On-Pack-Info	Legal Insert Downlight Slim
 Legal information	LSI DL SLIM
 Legal information	Informationstext 18 Abs 4 ElektroG
 Declarations of conformity	CE Certificate downlight Slim
 Declarations Of Conformity UKCA	DL SLIM WT IP20

Photometric and lighting design files		Document name
	IES file (IES)	DL SLIM SQ155 12W 4000K WT IP20
	LDT file (Eulumdat)	DL SLIM SQ155 12W 4000K WT IP20
	ULD file (DIALux)	DOWNLIGHTSLIMSQUARE15512W4000KWT
	ROLF file (RELUX)	DL SLIM SQ155 12W-4000K
	UGR file (UGR table)	4058075052543 DL SLIM SQ155 12W 4000K WT IP20
	LDC typ cone	4058075052543 DL SLIM SQ155 12W 4000K WT IP20
	LDC typ polar	4058075052543 DL SLIM SQ155 12W 4000K WT IP20

CAD/BIM files		Document name
	BIM_Revit_3D	Downlight Slim Square
	CAD_STEP_3D	DL SLIM SQ 155

Tender texts		Document name
	Tender documents	DOWNLIGHT SLIM SQUARE 155 12 W 4000 K WT-EN

**LOGISTICAL DATA**

Product code	Packaging unit (Pieces/Unit)	Dimensions (length x width x height)	Gross weight	Volume
4058075079298	Folding box 1	45 mm x 195 mm x 175 mm	359.00 g	1.54 dm <sup>3</sup>
4058075079304	Shipping box 6	290 mm x 205 mm x 195 mm	2374.00 g	11.59 dm <sup>3</sup>

The mentioned product code describes the smallest quantity unit which can be ordered. One shipping unit can contain one or more single products. When placing an order, for the quantity please enter single or multiples of a shipping unit.

**ADDITIONAL CATALOG INFORMATION**

