

PRODUCT DATASHEET

SF CIRCULAR 350 18 W 3000 K IP44 WT

SURFACE CIRCULAR 350 | Wall and ceiling luminaire with IP44



VALUE
CLASS

Areas of application

- Corridors
- Stairways
- Bathrooms
- Foyers

Product benefits

- Indoor luminaire with high luminous efficacy
- Energy savings of up to 55 % compared to luminaires that use CFL
- Easy and quick installation
- Very homogenous light
- 3 years guarantee

Product features

- Type of protection: IP44 (ceiling mounting), IP20 (wall mounting)
- Impact resistance: IK03
- Metal housing, PMMA cover
- Ambient temperature in operation: -20...+40 °C
- Indoor use only, not suitable for outdoor use



TECHNICAL DATA

Electrical data

Nominal wattage	18.00 W
Nominal voltage	220...240 V
Mains frequency	50...60 Hz
Nominal current	153 mA
Inrush current	15.0 A
Inrush current time T_{h50}	200 μ s
Max. number of luminaires per miniature circuit breaker B16	31
Max. number of luminaires per miniature circuit breaker C10	26
Max. number of luminaires per miniature circuit breaker C16	42
Power factor λ	> 0.5
Total harmonic distortion	< 120 %
Protection class	I
Operating mode	Integrated LED driver

Photometrical data

Luminous flux	1440 lm
Luminous efficacy	80 lm/W
Color temperature	3000 K
Light color (designation)	Warm White
Color rendering index Ra	> 80
Standard deviation of color matching	≤ 5 sdc _m
Low flicker	Yes
Photobiological safety group acc. to EN62778	RG0
Beam angle	120 °

0.5	1.70 1.69	E(0°) 1626 E(C90) 106 E(C0) 107
1.0	3.40 3.38	E(0°) 407 E(C90) 27 E(C0) 27
1.5	5.09 5.07	E(0°) 181 E(C90) 12 E(C0) 12
2.0	6.79 6.76	E(0°) 102 E(C90) 7 E(C0) 7
2.5	8.49 8.45	E(0°) 65 E(C90) 4 E(C0) 4
3.0	10.19 10.15	E(0°) 45 E(C90) 3 E(C0) 3
Distance [m]	Cone diameter [m]	Illuminance [lx]
— C0/C180 (Half beam angle [°]: 118.8°) — C90/C270 (Half beam angle [°]: 119.0°)		

Surface-C LED 350 18W 3000K

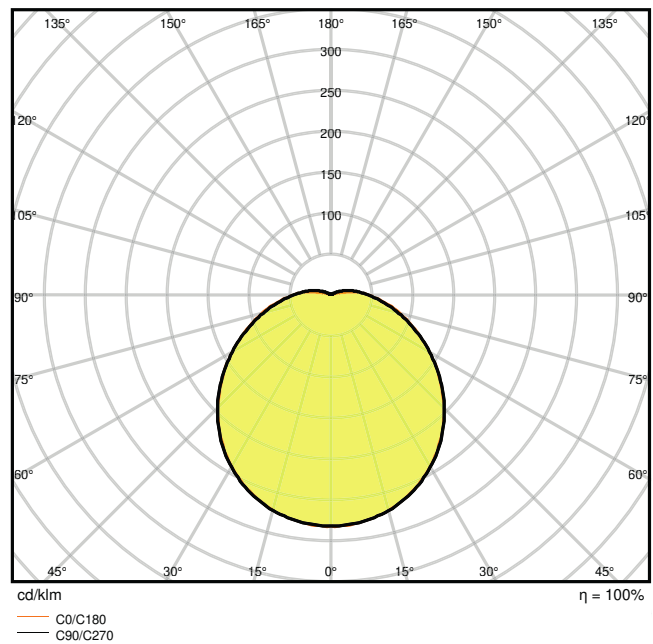

Surface-C LED 350 18W 3000K

Dimensions & Weight

Diameter	350.00 mm
Height	115.00 mm
Product weight	600.00 g

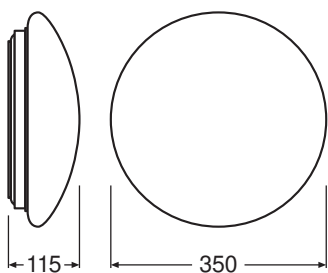

707543_LEDVANCE Surface Circular LED 350

Materials & Colors

Product color	White
Housing color	White

Body material	Steel
Cover material	Polymethylmethacrylate (PMMA)
Light emitting surface material	PMMA
Glow Wire Test according to IEC 60695-2-12	650 °C

Application & Mounting

Ambient temperature range	-20...+40 °C
Temperature range at storage	-25...+70 °C
Type of connection	Screw terminal, 3-Pole
Type of protection	IP44
Protection class IK (shock resistance)	IK03
Dimmable	No
Mounting type	Surface
Mounting location	Ceiling / Wall
Application environment	Indoor
LED module replaceable	Not replaceable

Lifespan

Lifespan L70/B50 at 25 °C	30000 h ¹⁾
Lifespan L80/B10 at 25 °C	22000 h ¹⁾
Lifespan L90/B10 at 25 °C	15000 h
Number of switching cycles	100000

¹⁾ t[h]: L70 / B50 @ 25 °C (Ta), t[h]: L80 / B10 @ 25 °C (Ta), t[h]: L90 / B10 @ 25 °C (Ta)

Control gear

Output current	117 mA
----------------	--------





Certificates & Standards







Standards	CE / CB / TÜV SÜD / EAC
Ball shot safe	No

EQUIPMENT / ACCESSORIES

– Replacement cover optional available

DOWNLOAD DATA

Documents and certificates		Document name
	User Instruction / Safety Instructions	SURFACE CIRCULAR
	On-Pack-Info	Legal Insert Surface
	Declarations of conformity	EU Declaration of Conformity SF Circular 350 400 IP44 LEDV
	Declarations of conformity	Attestation-of-Conformity SF Circular TÜV

Photometric and lighting design files		Document name
	IES file (IES)	Surface-C LED 350 18W 3000K
	LDT file (Eulumdat)	Surface-C LED 350 18W 3000K
	ULD file (DIALux)	SURFACECIRCULAR35018W3000KIP44WT
	UGR file (UGR table)	Surface-C LED 350 18W 3000K
	LDC typ cone	Surface-C LED 350 18W 3000K
	LDC typ polar	Surface-C LED 350 18W 3000K

Tender texts		Document name
	Tender documents	SURFACE CIRCULAR 350 18 W 3000 K IP44 WT-EN

LOGISTICAL DATA

Product code	Packaging unit (Pieces/Unit)	Dimensions (length x width x height)	Gross weight	Volume
4058075080010	Folding box 1	386 mm x 386 mm x 120 mm	969.00 g	17.88 dm ³
4058075080027	Shipping box 5	625 mm x 410 mm x 410 mm	5862.00 g	105.06 dm ³

The mentioned product code describes the smallest quantity unit which can be ordered. One shipping unit can contain one or more single products. When placing an order, for the quantity please enter single or multiples of a shipping unit.

ADDITIONAL CATALOG INFORMATION

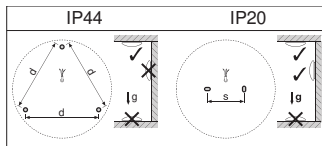

References / Links

– For Guarantee see www.ledvance.com/guarantee

DISCLAIMER

Subject to change without notice. Errors and omission excepted. Always make sure to use the most recent release.