

PRODUCT DATASHEET

PANEL PFM 600 30 W 4000 K WT

PANEL PERFORMANCE 600 | Square recessed panel luminaires, 600 x 600 mm

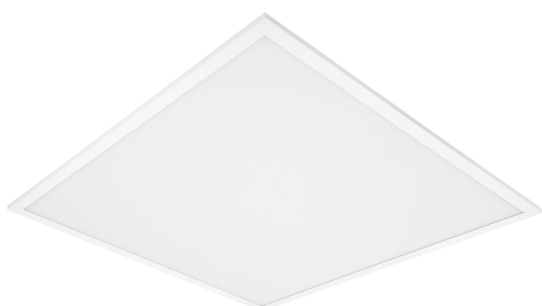

Areas of application

- Direct replacement for luminaires with fluorescent lamps
- Corridors
- Offices
- Conference rooms
- Reception areas
- Foyers
- Elevators
- Suitable for recessed ceiling systems with grid size of 600 x 600 mm

Product benefits

- Energy savings of up to 50 % (compared to luminaires that use fluorescent lamps)
- External driver for extended flexibility
- Light guide plate with micro structure made of non-yellowing material for long lifetime
- Easy and quick installation
- Low flicker light thanks to special electronic control gear
- 5 years guarantee

Product features

- High luminous efficacy: up to 110 lm/W
- Lifetime (L80/B10): up to 60,000 h (at 25 °C)
- Connector box with push wire terminal for tool-free connection
- Aluminum housing, polystyrene diffuser



TECHNICAL DATA

Electrical data

Nominal wattage	30.00 W
Nominal voltage	220...240 V
Mains frequency	50...60 Hz
Nominal current	170 mA
Inrush current	14.5 A
Inrush current time T_{h50}	153.8 μ s
Max. number of luminaires per miniature circuit breaker B16	41
Max. number of luminaires per miniature circuit breaker C10	33
Max. number of luminaires per miniature circuit breaker C16	52
Power factor λ	≥ 0.95
Total harmonic distortion	< 7 %
Protection class	II
Operating mode	External LED driver

Photometrical data

Luminous flux	3000 lm
Luminous efficacy	100 lm/W
Color temperature	4000 K
Light color (designation)	Cool White
Color rendering index Ra	≥ 80
Standard deviation of color matching	5 sdc _m
Low flicker	Yes
Photobiological safety group acc. to EN62778	RG0
Beam angle	120 °

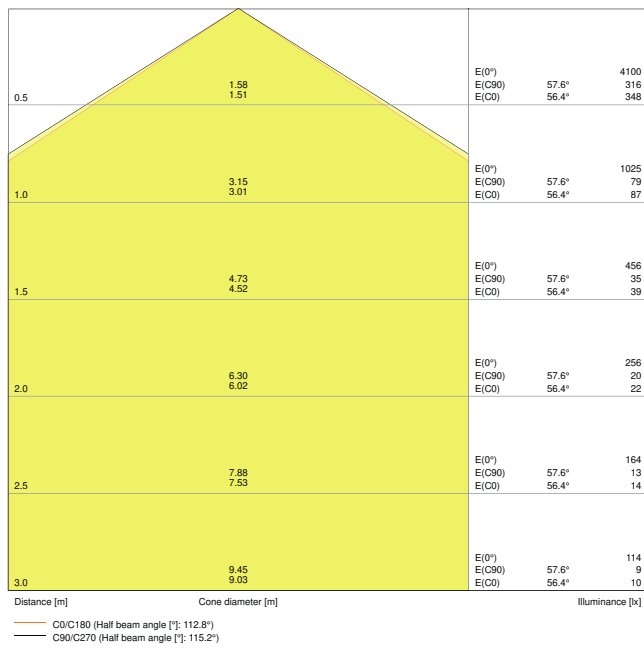

PL PFM 600 30W 4000K

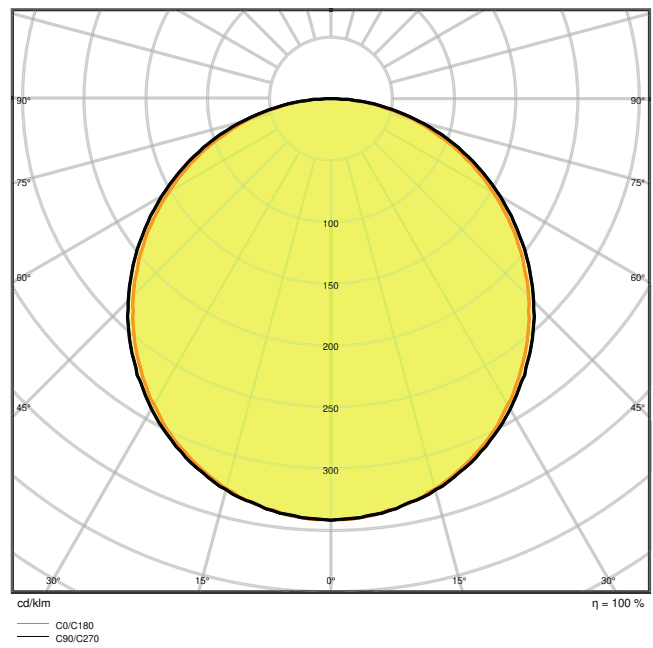

PL PFM 600 30W 4000K

Dimensions & Weight

Length	595.00 mm
Width	595.00 mm
Height	9.00 mm
Product weight	2000.00 g

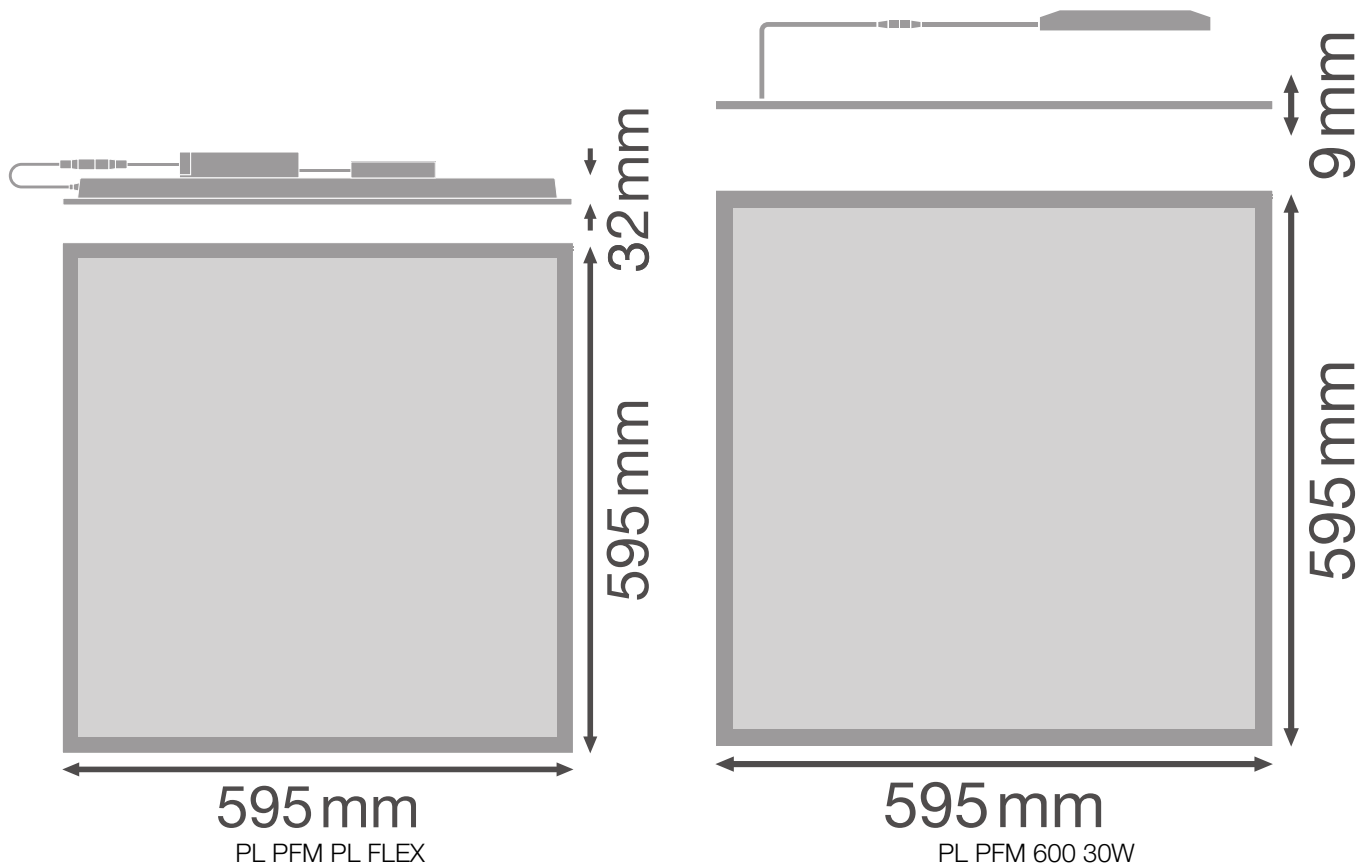

Materials & Colors

Product color	White
Housing color	White
Body material	Steel
Cover material	Polystyrene (PS)
Light emitting surface material	Polystyrene
Glow Wire Test according to IEC 60695-2-12	650 °C
Mercury content	0.0 mg

Application & Mounting

Ambient temperature range	-10...+45 °C
Type of connection	Cable, 3-pole
Type of protection	IP20
Protection class IK (shock resistance)	IK03
Dimmable	No

Mounting type	Recessed/Suspended/Surface
Mounting location	Ceiling / Wall
Application environment	Indoor
Mounting length	591 mm
Mounting width	591 mm
Mounting depth	50,0 mm

Lifespan

Lifespan L70/B50 at 25 °C	80000 h ¹⁾
Lifespan L80/B10 at 25 °C	60000 h ¹⁾
Lifespan L80/B50 at 25 °C	60000 h
Lifespan L90/B10 at 25 °C	35000 h
Number of switching cycles	25000

¹⁾ t[h]: L70 / B50 @ 25 °C (Ta), t[h]: L80 / B10 @ 25 °C (Ta), t[h]: L90 / B10 @ 25 °C (Ta)



Control gear





ECG - Output ripple current	< 5 %
-----------------------------	-------

Certificates & Standards

Standards	CE / CB / TÜV SÜD / EAC
Ball shot safe	No
Replaceable light source (EPREL)	Not replaceable

Accessories Optional



Product image	Product name	EAN
	PANEL Suspension Kit	4058075402928
	PANEL 600 SURFACE MOUNT KIT H75	4058075472914





Product image	Product name	EAN
	PANEL RECESSED MOUNT CLIPS VAL 4x	4058075409859
	PANEL 600 SURFACE MOUNT KIT H70 VAL	4058075402843
	PANEL 600 RECESSED MOUNT FRAME	4058075402881
	EM CONVERSION BOX	4058075237025

EQUIPMENT / ACCESSORIES

- Accessories for several mounting options available
- External control gear included
- Not suitable for use with Emergency Conversion Box

DOWNLOAD DATA

Documents and certificates		Document name
	User instruction / safety instructions	UI PANEL PFM 600_625
	Certificates	Certificate TUV PANEL PFM

Photometric and lighting design files		Document name
	IES file (IES)	PL PFM 600 30W 4000K
	LDT file (Eulumdat)	PL PFM 600 30W 4000K
	UGR file (UGR table)	PL PFM 600 30W 4000K
	Light distribution curve type cone	PL PFM 600 30W 4000K

Photometric and lighting design files	Document name
 Light distribution curve type polar	PL PFM 600 30W 4000K

Tender texts	Document name
 Tender documents	PANEL PERFORMANCE 600 30 W 4000 K WT-EN

LOGISTICAL DATA

Product code	Packaging unit (Pieces/Unit)	Dimensions (length x width x height)	Gross weight	Volume
4058075225176	Folding box 1	40 mm x 627 mm x 684 mm	2320.00 g	17.15 dm ³
4058075394629	Shipping box 6	782 mm x 150 mm x 687 mm	16063.00 g	80.59 dm ³

The mentioned product code describes the smallest quantity unit which can be ordered. One shipping unit can contain one or more single products. When placing an order, for the quantity please enter single or multiples of a shipping unit.

ADDITIONAL CATALOG INFORMATION

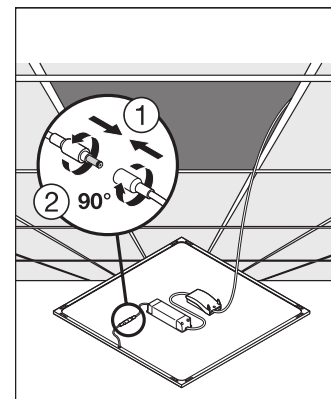
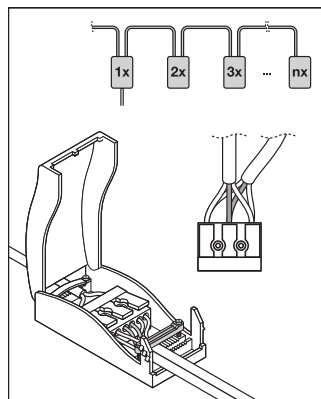
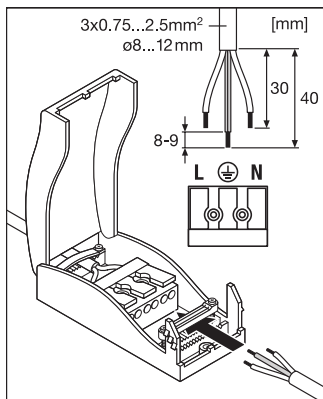

References / Links

– For Guarantee see www.ledvance.com/guarantee

DISCLAIMER

Subject to change without notice. Errors and omission excepted. Always make sure to use the most recent release.